

5	Cover	Stainless Steel	1		
4	Knob	Polyamide 6T	1		Black
3	Contact	Stainless Steel	1	Ag Clad	
2	Case	Polyamide 6T	1		Black
1	Terminal	Brass	1	Ag Plated	
NO.	Name	Material	Q'ty	Finish	Remarks

Part No.	High(H)	Package
STS-091	3.8 mm	2,000 Pcs/Reel
STS-091-D1	7.0 mm	750 Pcs/Reel

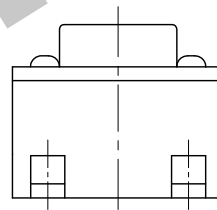

P.C.B TERMINAL POSITION

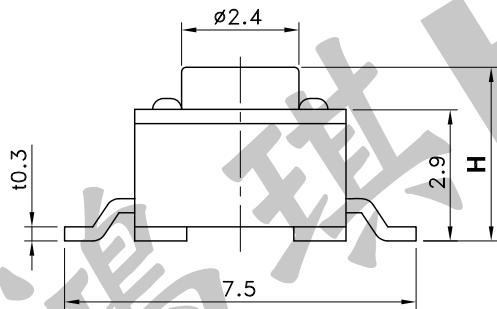
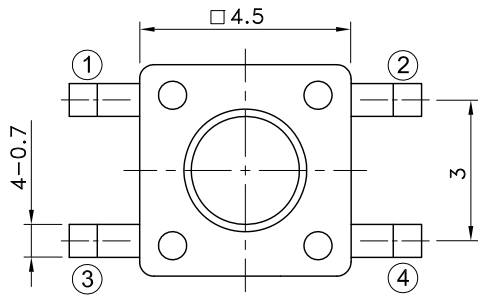
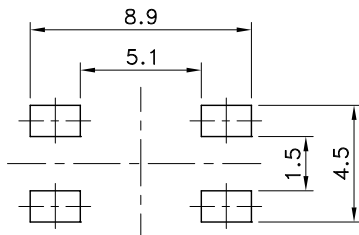

CIRCUIT ARRANGEMENT

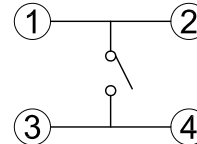

SOLDERING CONDITIONS

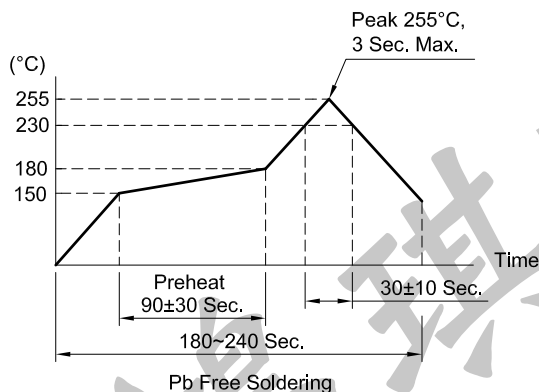

SPECIFICATIONS

- Rating : DC 12V 50mA Max.
DC 1V 10 μ A Min.
- Contact Resistance : 100m Ω Max.
- Insulation Resistance : 100M Ω Min. at DC 100V
- Dielectric strength : AC 100V for 1 Minute
- Operating Force : 160 \pm 30gf
- Stroke : 0.25 \pm 0.1mm
- Life : 100,000 Cycles
- Operation Temperature Range : -20~+70°C
- Storage Temperature Range : -30~+80°C

REVISION:	DATE:	REVISION:	DATE:
UNIT:mm	THIRD ANGLE PROJECTION METHOD	TOL. UNLESS OTHERWISE STATED:±0.3	CODE NO.:HCH-1116-11 (I)
ISSUED	CONFIRMED	PART NO.	
<i>John</i>	<i>Elvis</i>	STS-091	
2014.12.22	2014.12.22	STS-091-D1	
		HORNG CHIH 鴻琪股份有限公司	