

# PUSH SWITCHES

## PTS-180 2 POLES

- Rating: DC30V 100mA
- Stroke: Full 3 Lock 2mm
- Force: 240±100gf
- Life: 10,000 Cycles

PUSH TO LOCK: PTS-180S  
PUSH NO LOCK: PTS-180N

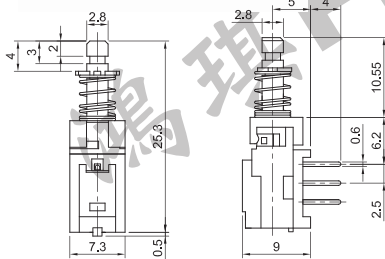

Mounting Hole Layout

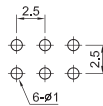

## PTS-110 2 POLES

- Rating: DC30V 100mA
- Stroke: Full 3.4 Lock 2.2mm
- Force: 250±80gf
- Life: 20,000 Cycles

PUSH TO LOCK: PTS-110S  
PUSH NO LOCK: PTS-110N

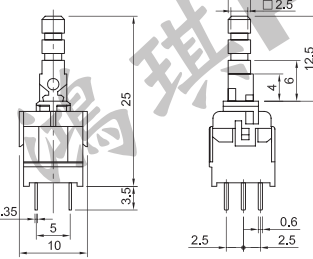

Mounting Hole Layout

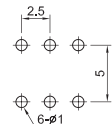

## PTS-181 4 POLES

- Rating: DC30V 100mA
- Stroke: Full 3 Lock 2mm
- Force: 280±100gf
- Life: 10,000 Cycles

PUSH TO LOCK: PTS-181S  
PUSH NO LOCK: PTS-181N

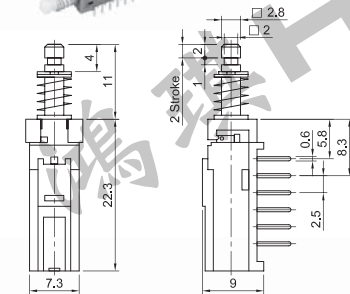

Mounting Hole Layout

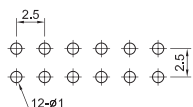

## WITH CHASSIS TYPE PTS-110C 2 POLES

- Rating: DC30V 100mA
- Stroke: Full 3.4 Lock 2.2mm
- Force: 250±80gf
- Life: 20,000 Cycles

PUSH TO LOCK: PTS-110C-S  
PUSH NO LOCK: PTS-110C-N

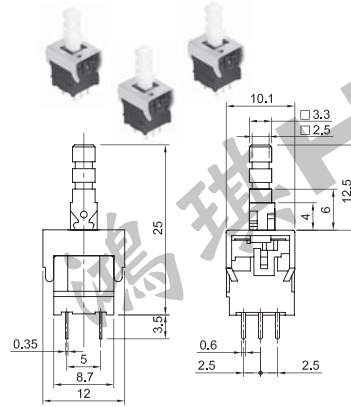

Mounting Hole Layout

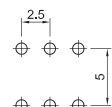

## PTS-182 6 POLES

- Rating: DC30V 100mA
- Stroke: Full 3 Lock 2mm
- Force: 330±100gf
- Life: 10,000 Cycles

PUSH TO LOCK: PTS-182S  
PUSH NO LOCK: PTS-182N

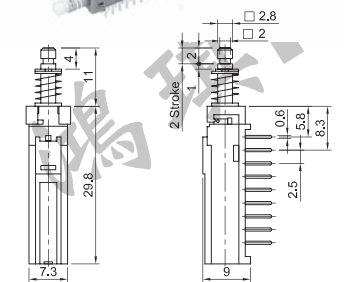

Mounting Hole Layout

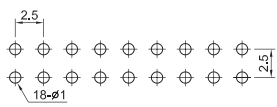

## PTS-111 4 POLES

- Rating: DC30V 100mA
- Stroke: Full 3.4 Lock 2.2mm
- Force: 280±100gf
- Life: 20,000 Cycles

PUSH TO LOCK: PTS-111S  
PUSH NO LOCK: PTS-111N

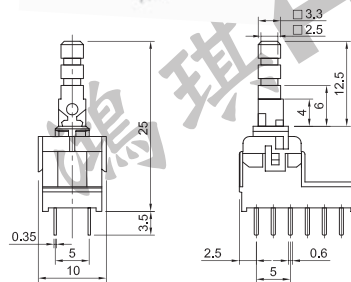

Mounting Hole Layout



## PTS-090 2 POLES

- Rating: DC30V 100mA  
DC25V 1A
- Stroke: Full 4.8 Lock 3.5mm
- Force: 400±100gf
- Life: 10,000 Cycles(DC30V 100mA)  
5,000 Cycles(DC25V 1A)

PUSH TO LOCK: PTS-090S  
PUSH NO LOCK: PTS-090N

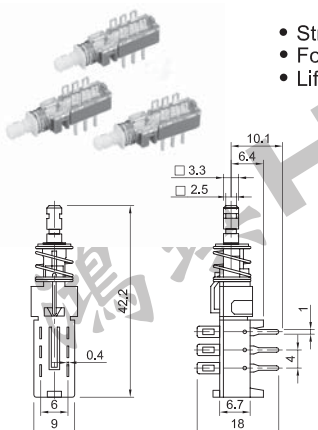

Mounting Hole Layout

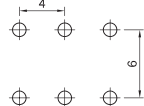

## PTS-112 6 POLES

- Rating: DC30V 100mA
- Stroke: Full 3.4 Lock 2.2mm
- Force: 300±100gf
- Life: 20,000 Cycles

PUSH TO LOCK: PTS-112S  
PUSH NO LOCK: PTS-112N

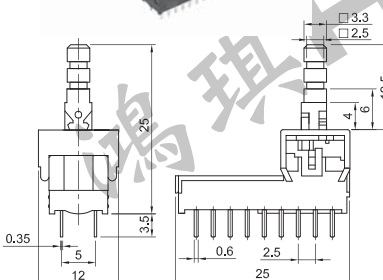

Mounting Hole Layout

