

SMT B TO B CONNECTOR

PITCH:0.5mm H:6.7mm
PLUG
BTB3 SERIES

- Rating: AC/DC50V 500mA
- Contact Resistance: 100mΩ Max.
- Dielectric Strength: AC250V for 1 Minute
- Pitch: 0.5mm
- Height: 6.7mm
- No. of Poles: 30~70 Poles
- Operating Temperature: -40 ~ +105°C
- Package: 1,000 Pcs/Reel

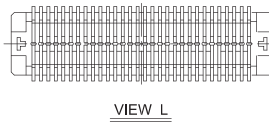
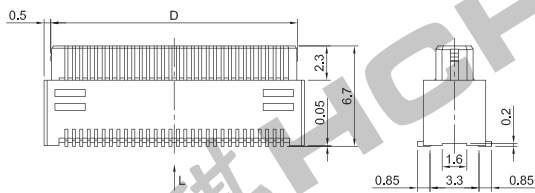
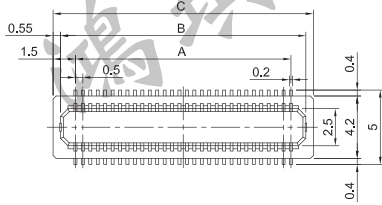
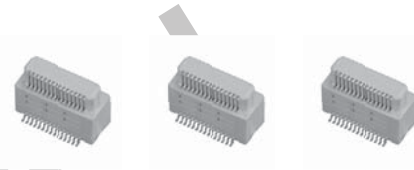

Pad Layout

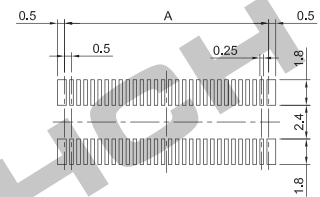

PARTS NO.	PIN	A	B	C	D	PARTS NO.	PIN	A	B	C	D
BTB3-30	30	7.00	8.90	10.00	9.00	BTB3-60	60	14.50	16.40	17.50	16.50
BTB3-40	40	9.50	11.40	12.50	11.50	BTB3-70	70	17.00	18.90	20.00	19.00
BTB3-50	50	12.00	13.90	15.00	14.00						

SMT B TO B CONNECTOR

PITCH:0.5mm H:3.5mm
SOCKET
BTB4 SERIES

- Rating: AC/DC50V 500mA
- Contact Resistance: 100mΩ Max.
- Dielectric Strength: AC250V for 1 Minute
- Pitch: 0.5mm
- Height: 3.5mm
- No. of Poles: 30~70 Poles
- Operating Temperature: -40 ~ +105°C
- Package: 1,000 Pcs/Reel

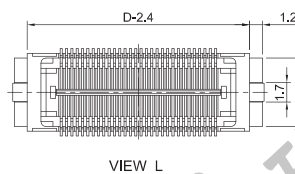
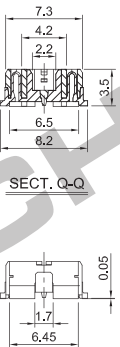
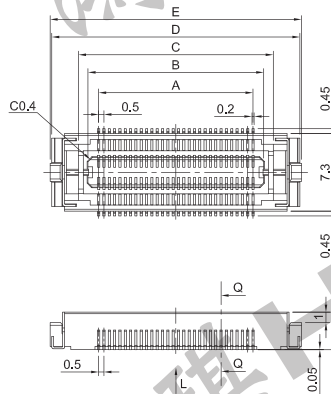

Pad Layout

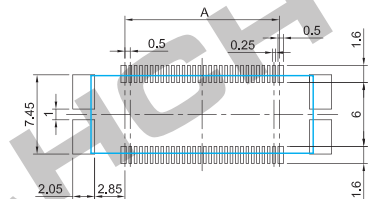

PARTS NO.	PIN	A	B	C	D	E	PARTS NO.	PIN	A	B	C	D	E
BTB4-30	30	7.00	9.00	10.80	15.80	16.10	BTB4-30	60	14.50	16.50	18.30	23.30	23.60
BTB4-40	40	9.50	11.50	13.30	18.30	18.60	BTB4-40	70	17.00	19.00	20.80	25.80	26.10
BTB4-50	50	12.00	14.00	15.80	20.80	21.10	BTB4-50						